

Steering Wheel Audio Control Interface Adapter



for Alpine, Pioneer, Sony, JVC,
Clarion head units



Plug adapter for
Blaupunkt head
unit



Plug adapter for
Kenwood head
unit



Plug adapter for
Panasonic,
JVC2,
Blaupunkt3

Wiring

Red: Power +12 V (ACC)

Black: Power GND

Brown: Audio remote ground (SWG)

Yellow: Audio remote switch (SW1) for Toyota, Nissan, Honda, Subaru, Hyundai, Kia, Mitsubishi, Rover, Alfa Romeo

Green: Audio remote switch (SW2) for Toyota, Nissan, Mazda, Opel, Ford, Alfa Romeo

White: I-BUS input for BMW

Blue, Gray, Violet, Black, Orange, Pink (grouped): Renault 3x3 matrix keypad with roller

Orange, Brown (grouped): External optional infrared (IR) diode (orange: anode)

Note:

1) In case of missing audio remote ground (SWG) connection point in given vehicle it is recommended to connect negative power (black) wire of the adapter to the point with less impedance for example to ground wire of lighter.

2) An optional plug adapter is required to connect steering wheel adapter equipped by Jack 3.5 connector to Blaupunkt, Kenwood and Panasonic head units.

3) To configure adapter for work with certain head unit brand use steering wheel buttons to type appropriate programming sequence listed in [table](#) on next page of this document. Configuration will not be cleared after power off. **Programming is possible only if steering wheel has all necessary buttons: “vol+”, “vol-”, “seek+”, “seek-”**

Внимание:

1) В случае отсутствия отдельного провода со стороны автомобиля для подключения SWG рекомендуем подключать землю питания (черный провод) адаптера к точке с минимальным сопротивлением, например к отрицательному проводу прикуривателя.

2) Для подключения адаптера, оснащенного разъемом Jack 3.5, к магнитолам марок Blaupunkt, Kenwood и Panasonic, требуется дополнительный переходник.

3) Чтобы сконфигурировать адаптер для работы с требуемой маркой магнитолы нужно, используя кнопки на руле, набрать соответствующую последовательность из [таблицы](#) на следующей странице этого документа. Конфигурация сохраняется и после выключения питания. **Программирование возможно только при наличии всех необходимых кнопок: “vol+”, “vol-”, “seek+”, “seek-”**

Programming Sequences

Alpine	:	-	+	↑	+	↓	+	↓	↑	↓	↑	+	↑	↓	↑	↓	+	↓
Pioneer	:	-	+	↓	↑	↓	+	↑	+	↓	↑	+	↑	↓	↑	↓	+	↓
Pioneer2	:	-	+	↓	↑	↓	+	↑	+	↓	↑	+	↑	↓	+	↓	+	↓
Kenwood	:	-	↑	+	↑	↓	↑	↓	+	↓	+	↑	+	↓	+	↓	↑	↓
Kenwood2	:	-	↑	+	↑	↓	↑	↓	+	↓	+	↑	+	↓	+	↓	+	↓
Sony	:	-	↑	↓	+	↓	↑	+	↑	↓	+	↑	+	↓	+	↓	↑	↓
JVC	:	-	+	↓	+	↓	↑	↓	↑	↓	+	↑	+	↓	+	↓	↑	↓
JVC2	:	-	+	↓	+	↓	↑	↓	↑	↓	+	↑	+	↓	↑	↓	+	↓
Blaupunkt	:	-	↑	↓	↑	↓	+	↑	+	↓	+	↓	↑	↓	↑	+	↑	↓
Blaupunkt2	:	-	↑	↓	↑	↓	↑	↓	+	↓	+	↑	+	↓	↑	+	↑	↓
Blaupunkt3	:	-	↑	↓	↑	↓	+	↓	+	↓	↑	↓	+	↓	+	↓	↑	↓
Panasonic	:	-	+	↑	+	↓	↑	↓	↑	↓	↑	+	↑	↓	+	↓	↑	↓
Clarion	:	-	+	↓	↑	↓	+	↓	+	↓	↑	↓	+	↓	+	↑	+	↓
Clarion2	:	-	+	↓	↑	↓	+	↓	+	↓	↑	↓	+	↓	↑	+	↑	↓
BMW_ext*	:	-	↑	↓	↑	↓	+	↓	↑	↓	↑	+	↑	↓	↑	↓	+	↓
SeekPreSwap*	:	-	↑	↓	↑	↓	↑	+	↑	↓	↑	↓	+	↓	+	↓	+	↓
UsePhoneBtn*	:	-	↑	+	↑	↓	↑	↓	↑	↓	+	↓	+	↓	+	↑	+	↓

Alpine	:	-	+	»	+	«	+	«	»	«	»	+	»	«	»	«	+	«
Pioneer	:	-	+	«	»	«	+	»	+	«	»	+	»	«	»	«	+	«
Pioneer2	:	-	+	«	»	«	+	»	+	«	»	+	»	«	+	«	+	«
Kenwood	:	-	»	+	»	«	»	«	+	«	»	+	»	«	+	«	»	«
Kenwood2	:	-	»	+	»	«	»	«	+	«	»	+	»	«	+	«	+	«
Sony	:	-	»	«	+	«	»	+	»	«	+	»	+	«	+	«	»	«
JVC	:	-	+	«	+	«	»	«	»	«	»	+	»	«	»	«	+	«
JVC2	:	-	+	«	+	«	»	«	»	«	»	+	»	«	»	«	+	«
Blaupunkt	:	-	»	«	»	«	»	«	+	«	»	+	»	«	»	+	»	«
Blaupunkt2	:	-	»	«	»	«	»	«	+	«	»	+	»	«	»	+	»	«
Panasonic	:	-	+	»	+	«	»	«	»	«	»	+	»	«	»	«	+	«
Blaupunkt3	:	-	»	«	»	«	»	«	+	«	»	+	»	«	»	«	+	«
Clarion	:	-	+	«	»	«	»	«	+	«	»	«	+	«	»	+	»	«
Clarion2	:	-	+	«	»	«	»	«	»	«	»	«	+	«	»	+	»	«
BMW_ext*	:	-	»	«	»	«	»	«	»	«	»	+	»	«	»	«	+	«
SeekPreSwap*	:	-	»	«	»	«	»	«	»	«	»	«	+	«	»	«	+	«
UsePhoneBtn*	:	-	»	+	»	«	»	«	»	«	»	«	+	«	»	«	+	«

↑, » = Seek +

↓, « = Seek -

“+” = Volume Up

“-” = Volume Down

* (en) BMW_ext: Turn On/Off usage of “R/T” and “Voice” buttons on BMW steering wheel as “Mute”(Att) and “Mode”. Initially this option is OFF.

SeekPreSwap: Reassignment of buttons functions: swap around commands “Seek/Track” and “Preset/Disk/Folder”. In case of presence of only “Seek+/-” buttons, initially short pressing is translated to “Seek/Track” command and prolonged pressing – to “Preset/Disk/Folder” command.

UsePhoneBtn: Send phone control commands. By default “On-hook/Off-hook” buttons on steering wheel causes sending of “Mute” command to head-unit.

* (lv) BMW_ext: **Aktivizēt/ deaktivizēt pogu “R/T” un “Voice” pogu izmantošu uz BMW stūres attiecīgi kā funkciju “Mute/ ATT” un “Mode”. Sākotnēji šī iespēja ir deaktivizēta.**

SeekPreSwap: Pogu funkciju atkārtota iestatīšana: apmainīt vietām komandas “Seek/Track” un “Preset/Disk/Folder”. Gadījumā, ja stūre aprīkota tikai ar “Seek +/-” pogām, sākotnēji īsie pogas spiedieni izpildīs “Seek/Track”, bet garie spiedieni “Preset/Disk/Folder” funkciju.

UsePhoneBtn: Tālruņa vadības komandu pārraide. Pēc noklusēšanas, “On-hook/Off-hook” stūres pogas izsauc komandu “Mute”.

* (ru) BMW_ext: Активация/деактивация использования кнопок “R/T” и “Voice” на руле BMW в качестве “Mute”(Att) and “Mode”. Изначально, опция деактивирована.

SeekPreSwap: Переназначение функций кнопок: обмен местами команд “Seek/Track” и “Preset/Disk/Folder”. Если присутствуют только кнопки “Seek+/-”, изначально, короткое нажатие передает команду “Seek”, а длинное — “Preset”.

UsePhoneBtn: Посылать команды управления телефоном. Изначально, кнопки поднятия/опускания трубки вызывают посылку команды “Mute”.

Pinouts

ALFA ROMEO

156 (2000->), 147 (2000->),
GT (2004->)

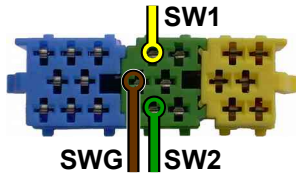

HONDA

Accord VII

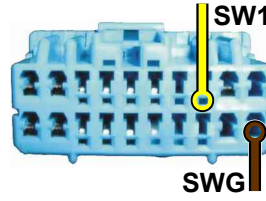

CR-V 2003

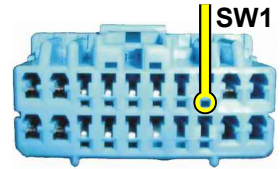

CR-V 2004-2007

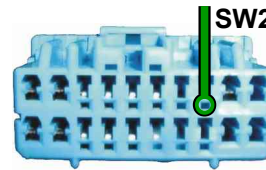

CR-V 2007->,
Civic 4D, 5D 2006->

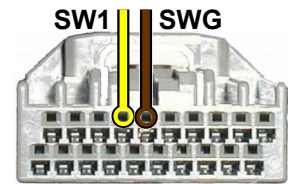

FORD

Focus II, C-Max, Kuga, Galaxy 2007->
Fusion, Mondeo 2007



HYUNDAI, KIA

SantaFe, NF, Grandeur, Elantra, Sonata, ix55,
Sorento 2006->, Magentis 2006->, Opirus

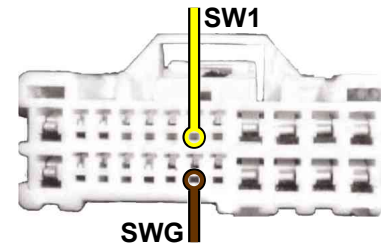

Focus 2005

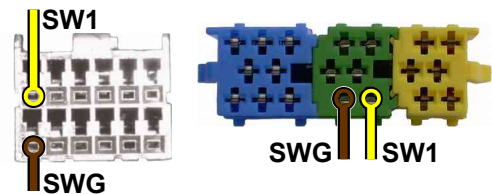
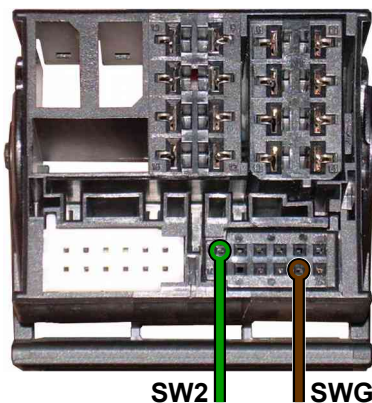

i30 2013, ix35/i40 2013

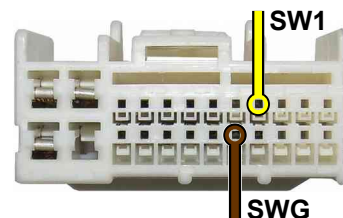

Jaguar

S-Type (1999)



XKR (2007)

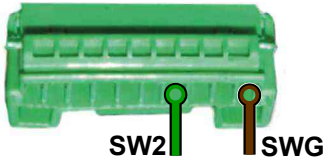

XK8 (2007)

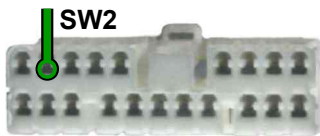

NISSAN

Maxima, Micra, Note, Patrol, X-trail 2007←, Murano, Navara, Titan, Pathfinder, Qashqai, Juke

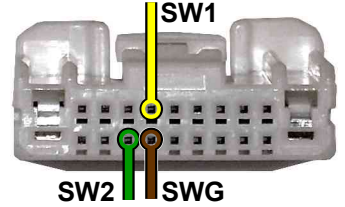
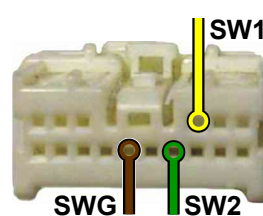
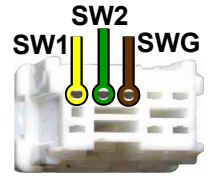
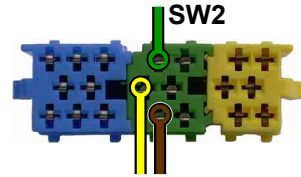

Land Rover

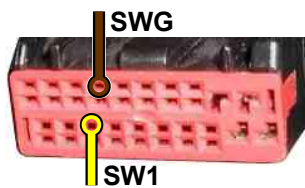

OPEL

Astra G, Omega B, Vectra B, Zafira A

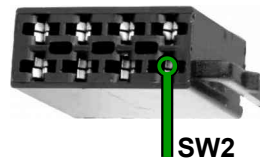

MAZDA

3, 5, 6, CX-7, CX-9, MPV

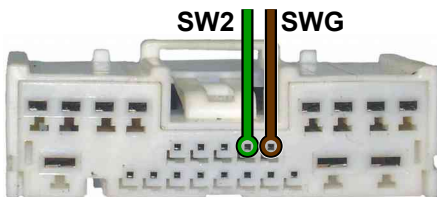

Peugeot

406 2001

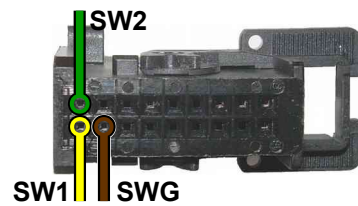

Rover 75

mitsubishi

Outlander (2009, 2011), Lancer X, Pajero, Galant IX (2008)

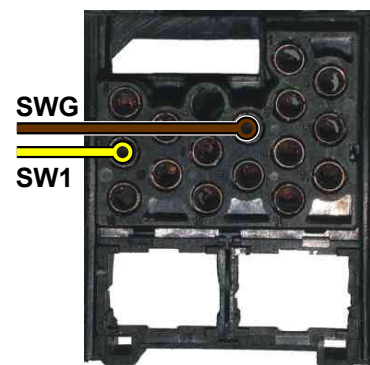
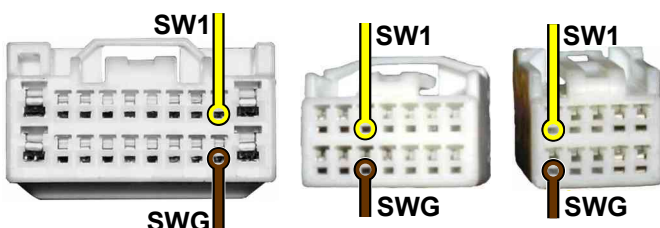

Ssang Yong

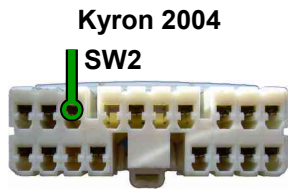

SUZUKI

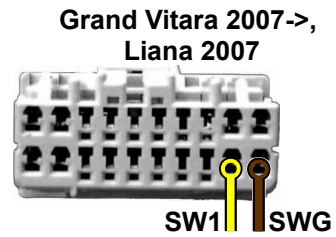

SUBARU

Forester 2006->, Impreza 2011, Tribeca, Outback 2006->

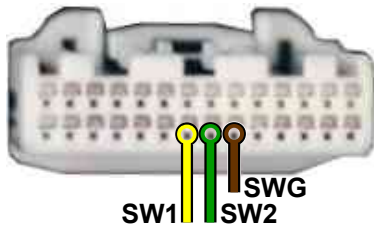
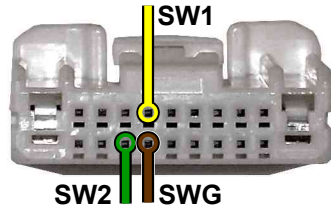
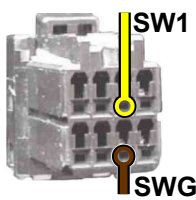
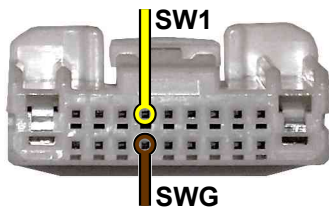

TOYOTA, LEXUS

exc. Corolla Verso, exc. LS

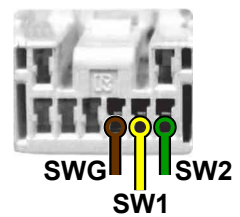
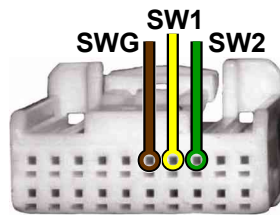

BMW

BMW3 (E46) 1998->2003, BMW5 (E39) 1996->2001
BMW7 (E38) 1994->2003
BMW5 (E56) 2000->2001

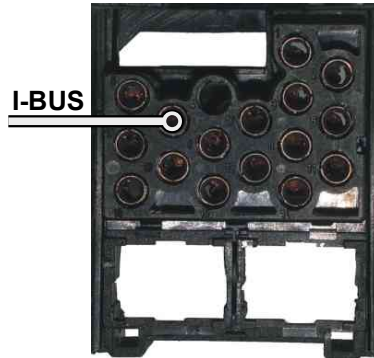

BMW3 (E46) 2001->2005, BMW5 (E39) 2001->2003
BMWMini 2001->, BMWX3 2004->
BMW5 (E53) 2001->, BMWZ4 2003->

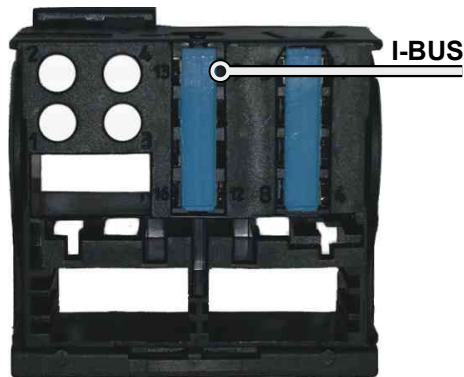

Chrysler, Dodge, Jeep



RENAULT

Trafic 2007, Clio 2006,
Laguna 2005

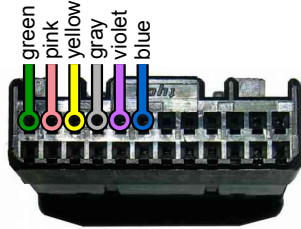

Laguna 2002, Trafic 2005

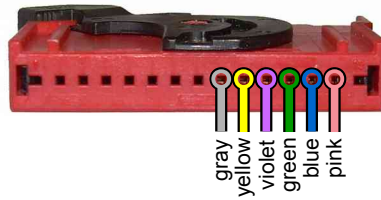

Trafic 2003

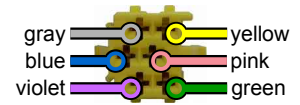

Scenic 2012

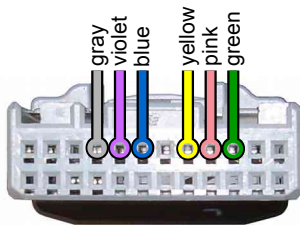

Scenic 2005

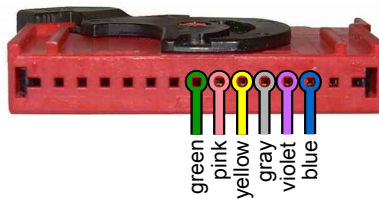

3x3 matrix keypad with roller

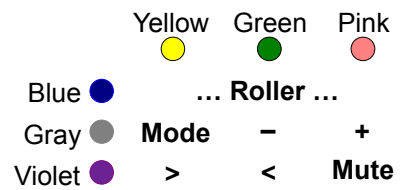

Harley Davidson

6 buttons

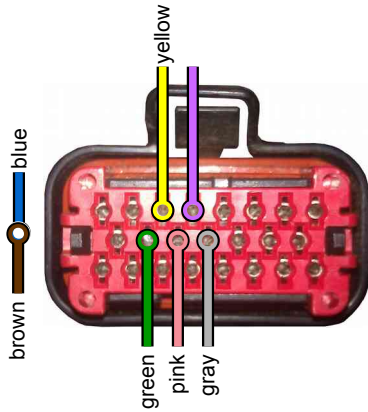

6 buttons

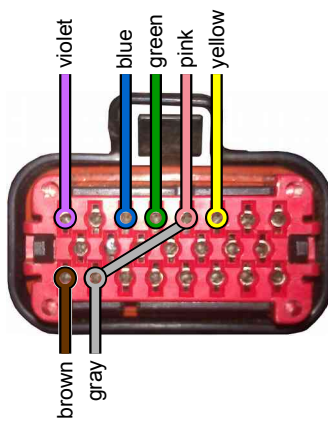

6 + 3 buttons

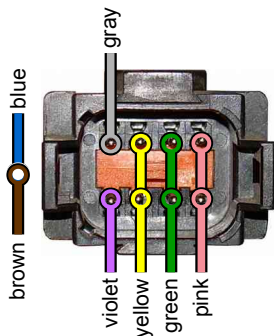
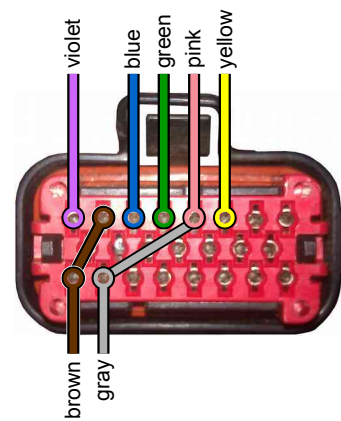

Document History

Doc. Rev.	Firmware	Date	Description
1.21	#1199	26.05.2016	Peugeot 406 2001
1.20		26.05.2016	Chrysler, Dodge, Jeep connectordiagram
1.19	#1195	26.05.2016	Blaupunkt3 (Android, adaptive resistive inputs); Pages reorder
1.18	#1185	09.04.2016	Jaguar S-Type 1999 has no SWG
1.17	#1185	05.04.2016	Jaguar S-Type 1999
1.16		24.03.2016	Renault Laguna 2005
1.15		21.01.2016	Renault Trafic 2005
1.14	#1077	22.08.2015	JVC2
1.13		22.08.2015	Correct position of Renault pictures from rev. 1.12
1.12		20.08.2015	Honda CR-V 2004-2007: correct wire connection
1.11		01.06.2015	Renault Trafic 2007 / Clio 2006: correct wires connections
1.10		13.05.2015	Harley Davidson.
1.9		11.05.2015	Subaru: Impreza 2011, Forester 2013; Ford Focus 2005; Hyundai i30 2013, ix35/i40 2012; Nissan Juke, Ssang Yong Kyron 2004, Rover 75, Land Rover, Honda CR-V 2004-2007 Renault Trafic 2003 color correction Unified design of wire connections
1.8		11.12.2014	Correct connections for Renault: Traffic 2003, Traffic 2007, Laguna 2002, Scenic 2005, Scenic 2012, Clio 2006
1.7	#984	26.11.2014	Kenwood2 and Clarion2, Document History
1.6	#968	21.07.2014	Pioneer2